

SDT-SN50 (バルブ付)
09160610
SCL=1/5

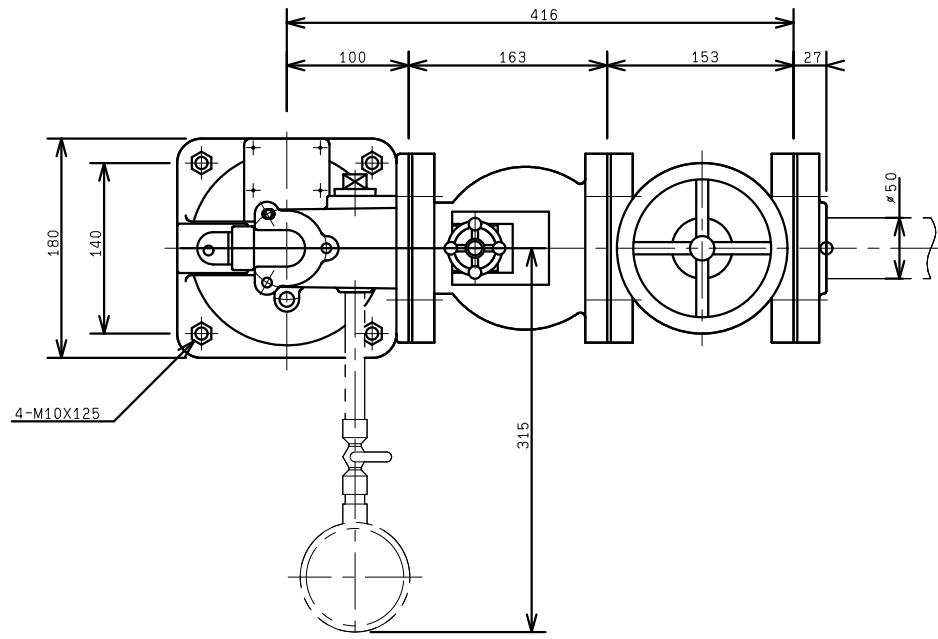

平面図

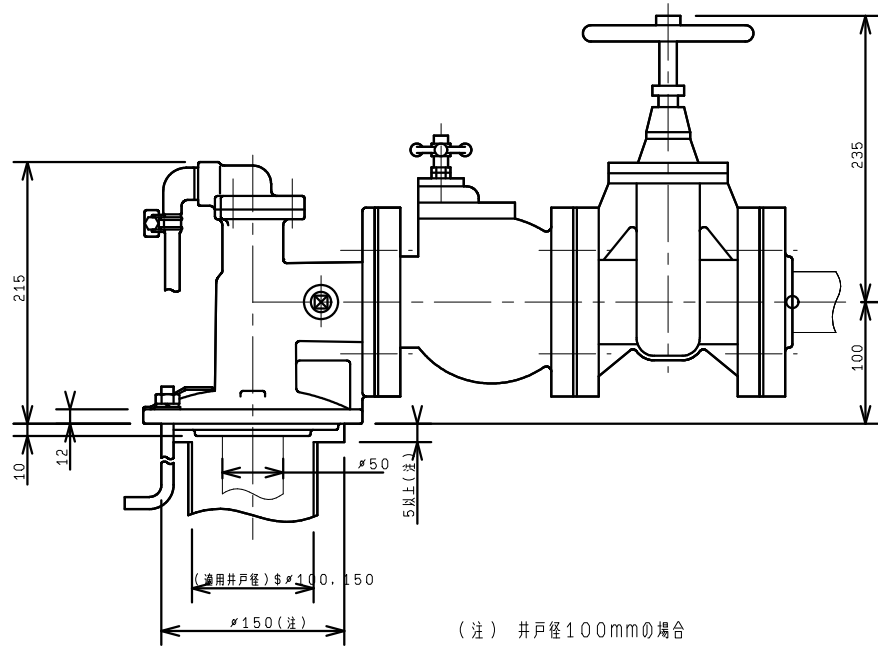

(注) 井戸径100mmの場合

正面図