

SDT-S65 (バルブ付)
09151510
SCL=1/5

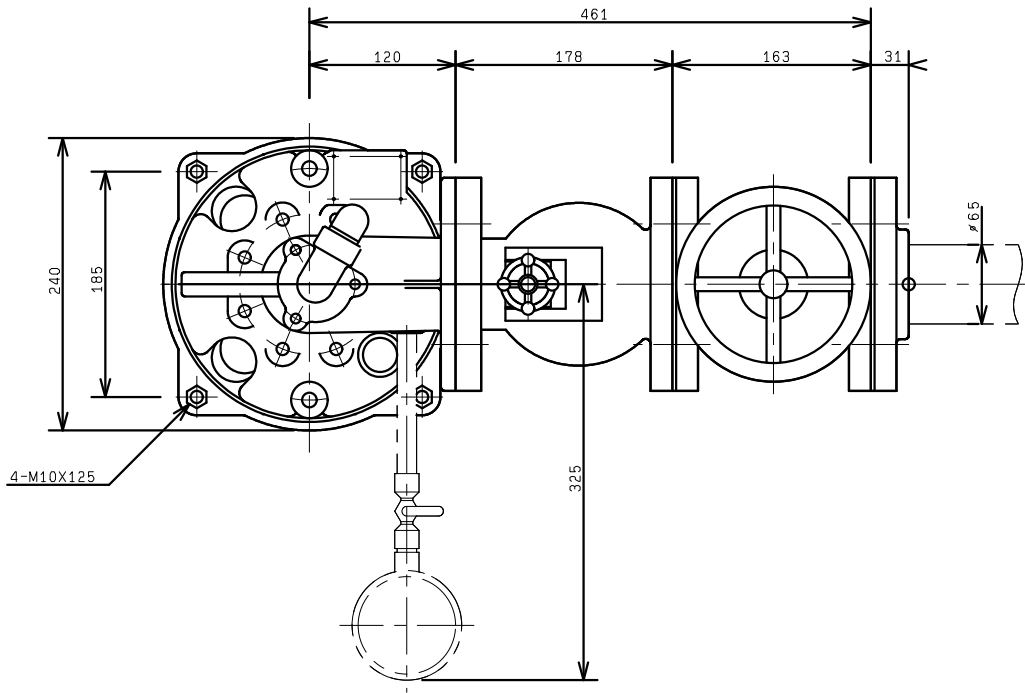

平面図

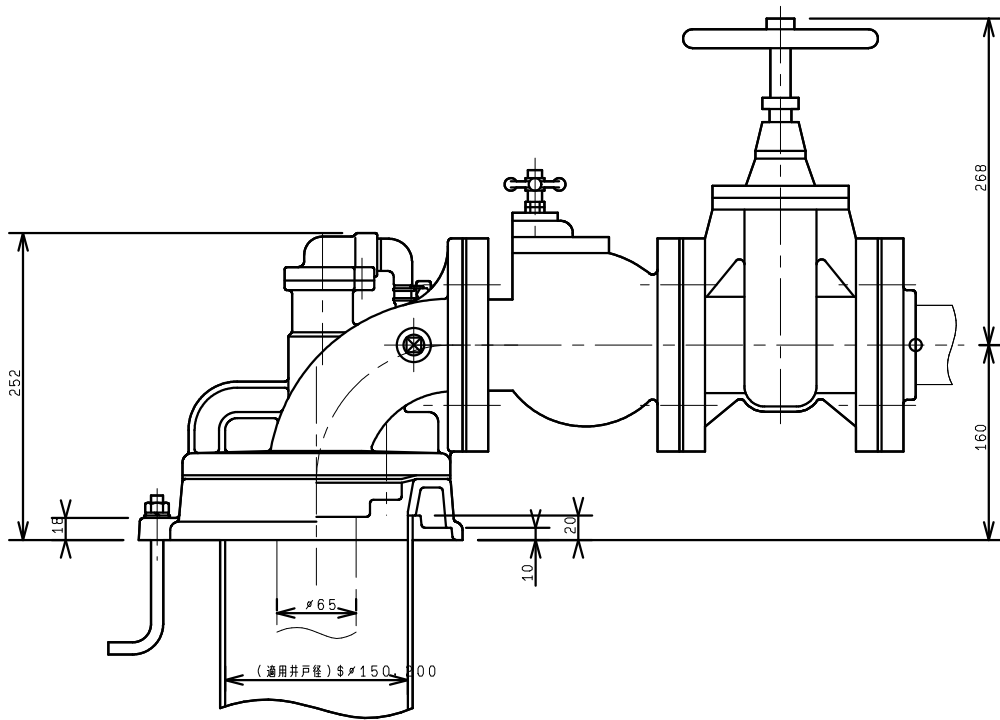

正面図