

SDP80R2. 2A  
 SDP80R3. 7A  
 SDP80R5. 5A  
 SDP80R7. 5A  
 (VC80)

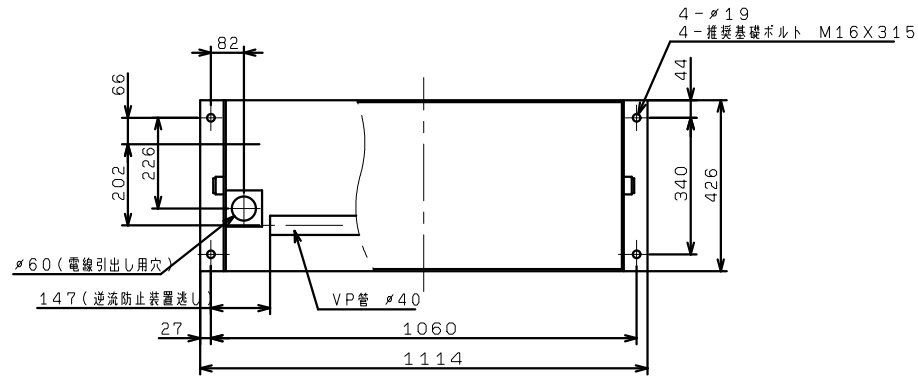

断面A A (本体下部詳細)

