

RCC4-9/9F

回転方向

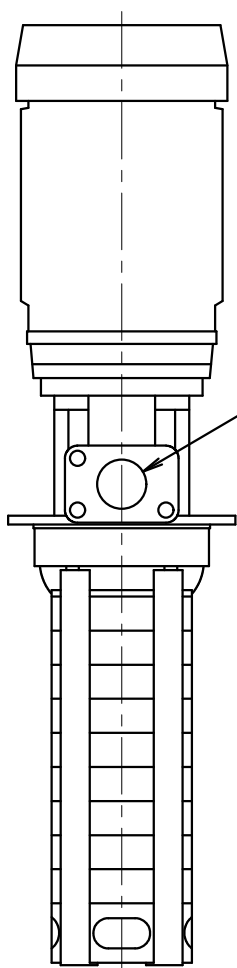

Rp1. 1/4

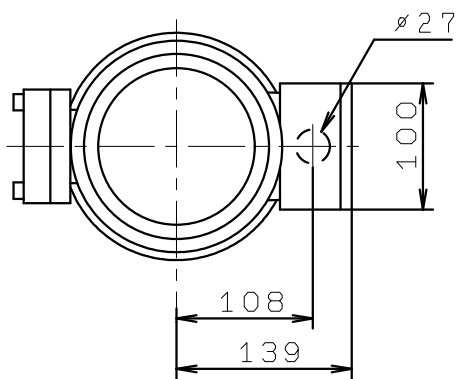