

KB2-505PE2.2
(VC81)

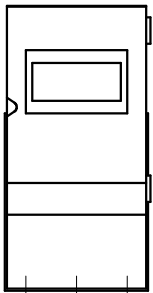

(制御盤正面図)

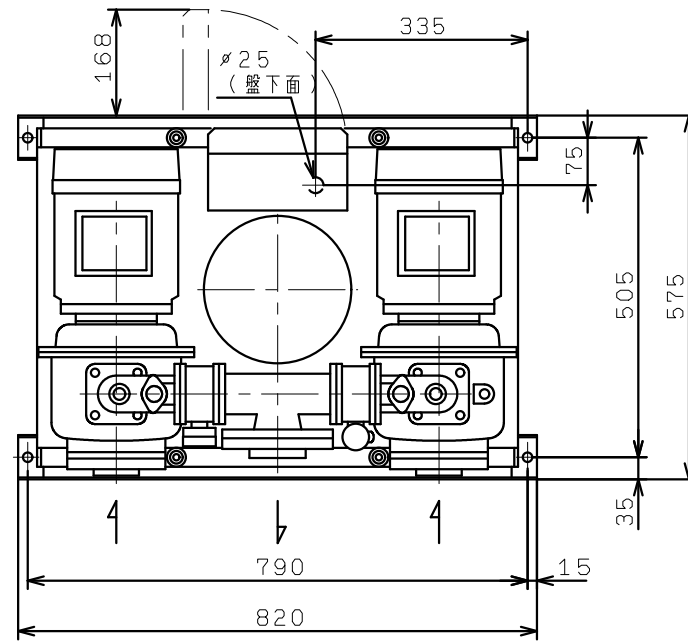