

KB2-505AE2.2  
(VC81)

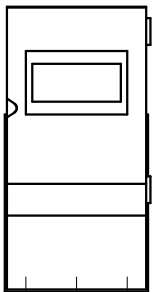

(制御盤正面図)

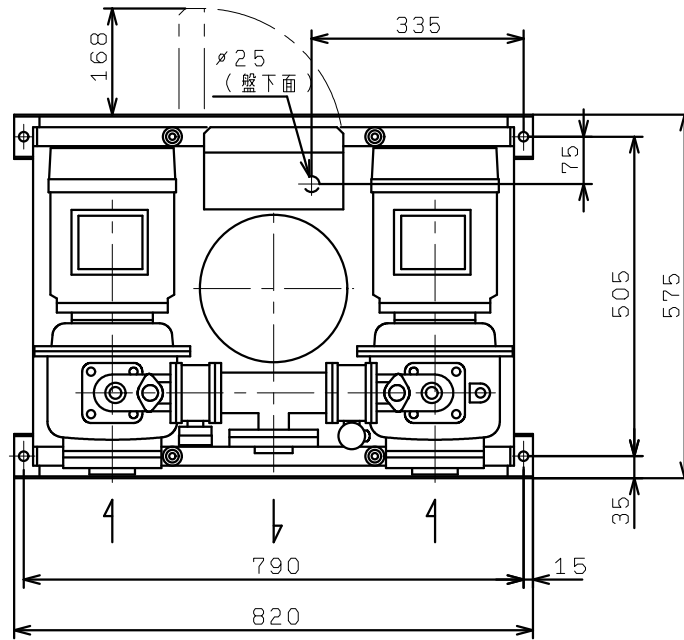