

KB2-326SE1.1
(VC42, 43, 44)

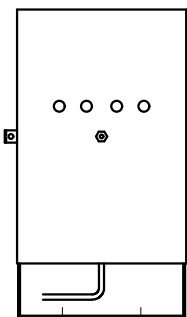

(制御盤正面図)

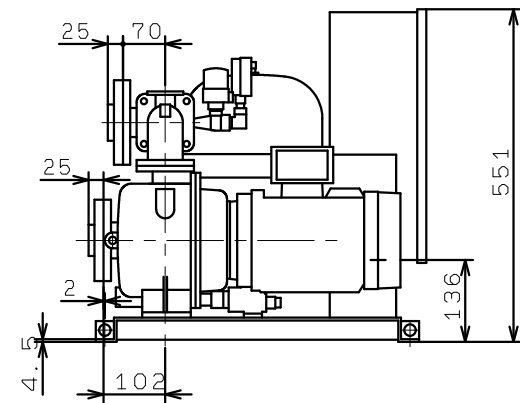
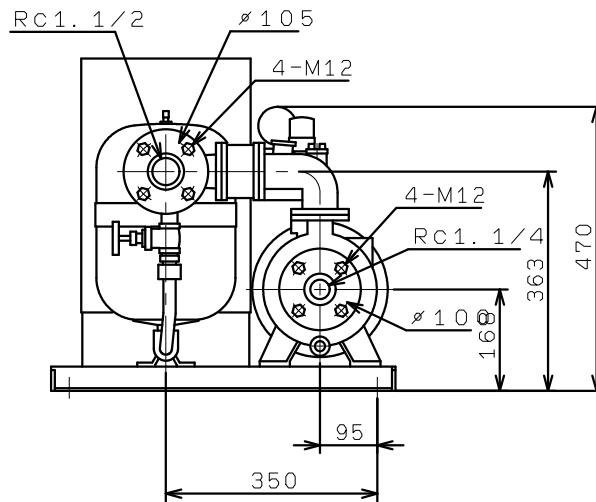
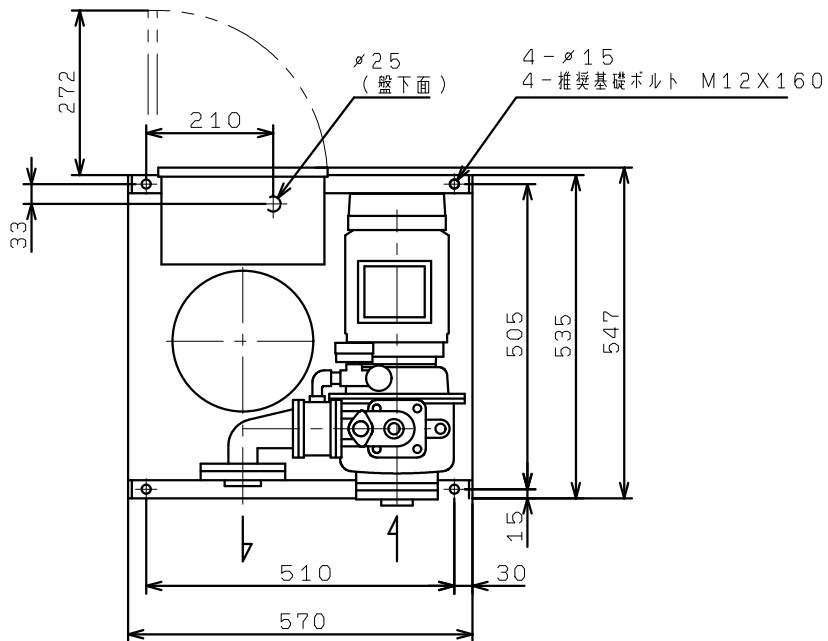